

Dome 10m

Data Sheet

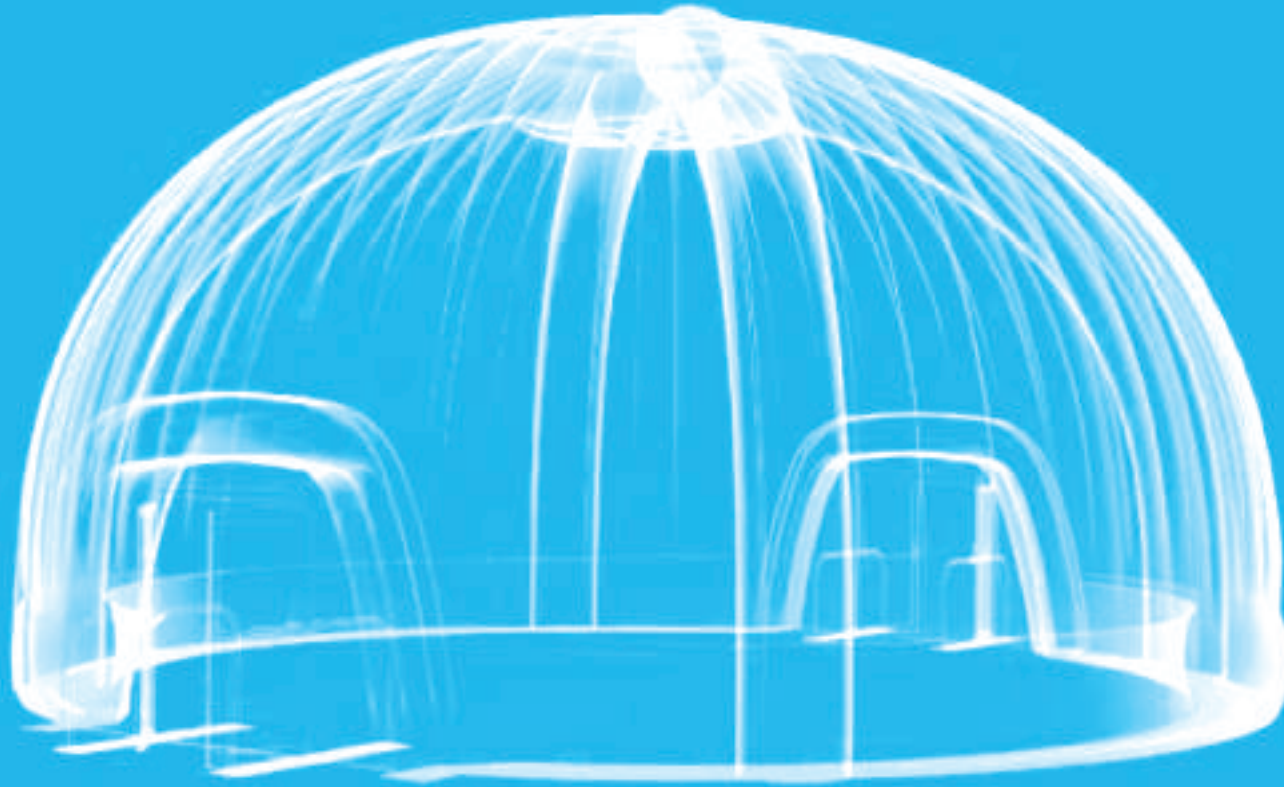

Product Variations

Inspire is a brand new range of high performance, beautifully designed, and practical temporary event structures.

Traditionally inflatable structures have been light weight and open to abuse from weather and more importantly the wind. The new Inspire range offers greatly improved performance through extensive design and engineering. Inspire inflatable event structures can withstand wind speeds and gusts of up to 55mph therefore ensuring your event is not effected at anytime of the year. Creatively designed, the M3 Air products are the worldwide leader in inflatable structures. **The Inspire Dome range includes:**

Inspire Dome Air- Beam collection

The highest rated inflatable temporary dome on the market can be used in winds up to 55mph. This is because of the regulated pressurised air beams which provide a solid support skeleton to the overall structure. An Inspire dome offers a contemporary look and market leading performance.

Inspire Dome standard collection

The Standard Inspire Dome range offers the same high class finish and look, and are the same product in every way, apart from the Air beams. This efficient, professionally made unit offers a superb solution to any event.

The Inspire range of structures can be tailored to suit your event needs, we offer branding with options including direct print and replaceable printed covers. The Inspire range also offers great flexibility as all the products can be seamlessly joined together, providing wonderful multi room environments. We also offer a range of connecting tunnels to add a sleek finish to the event structures.



General Arrangement

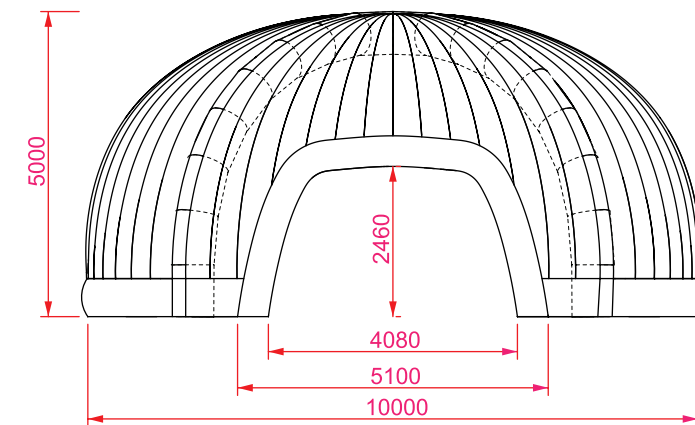

FRONT ELEVATION

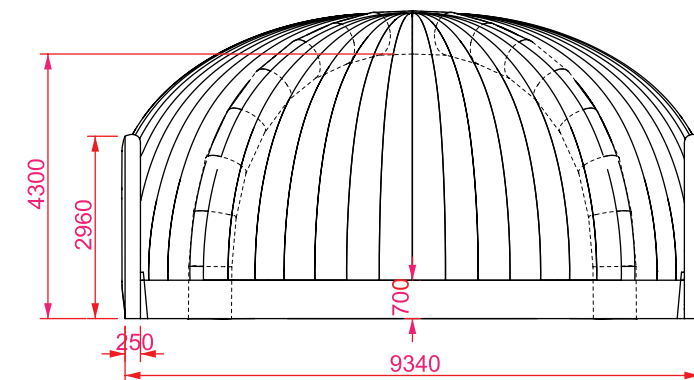

SIDE ELEVATION

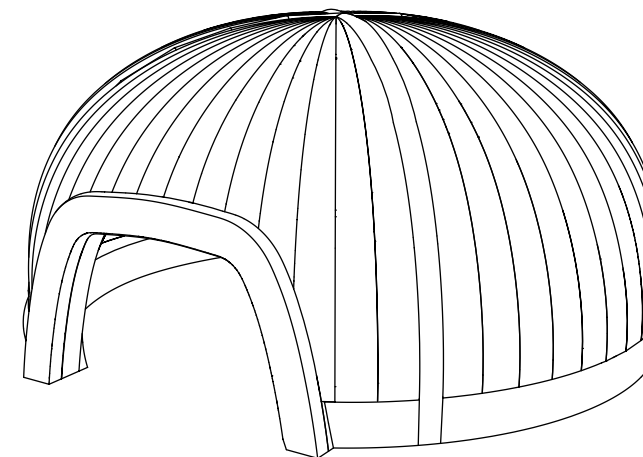

PERPECTIVE VIEW

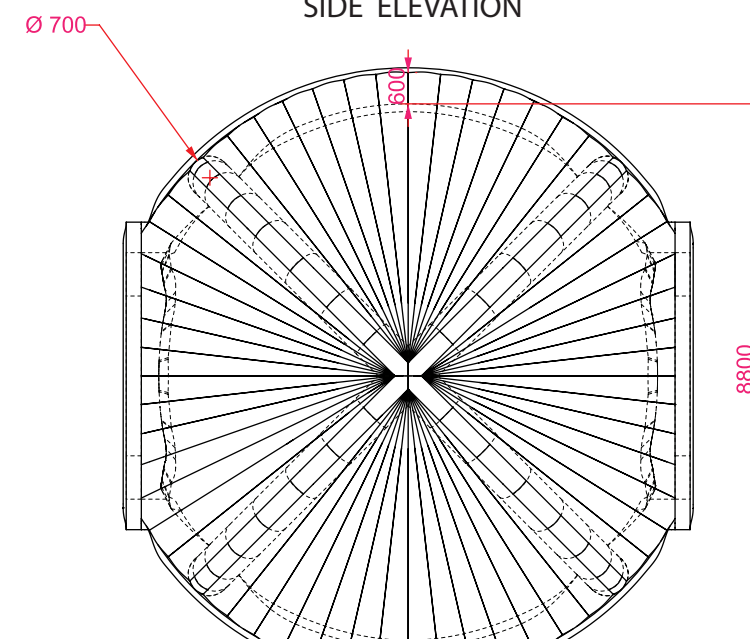

PLAN



Product Accessories

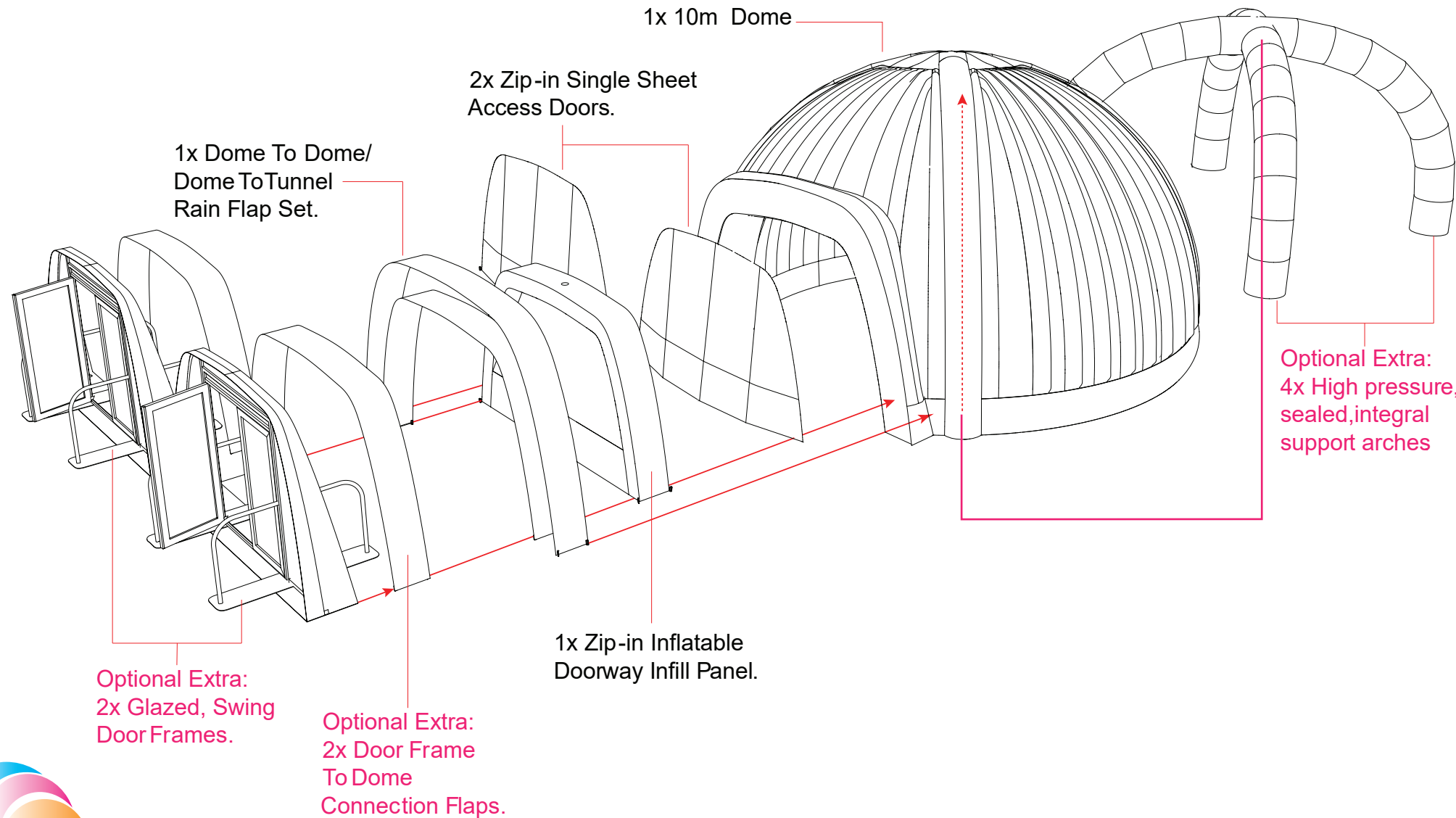

Product Specification

PACKAGE

- 1 x Structure, 1 x Packing Bag, 2x Zip-in access doors, 1x zip-in inflatable door panel, 6x FG12 fans.

STRUCTURE

Packed Size: • 1200mm x 1000mm x 800mm (est.)

Packed Weight: • 300kg (est.)

Inflated Size: • External - Ø10m x H5m

• Internal - Ø8.8m x H4.3m

Internal Floor Area: • 57.6m²

Plot Size Required: • 11m x 11m plus

Entrance/Exit Size: • W4.08m, H2.46m

Fabrics: • PVC, rip stop nylon FR treated

Colours: • Combinations of white/black/silver/frosted

Ground Fixings: • Available upon request

Please Note: Information is correct at time of publication. Ingenious inflatables ltd accept no responsibility for variations in dimensions or weights. Ingenious inflatables ltd reserve the right to alter any dimensions or weights at any time without prior notice.

POWER & FANS

Fans: • 6x FG12 fans

Pumps: • 120v

Min Secure Power: • 120v

Fan Weight: • 8kg per fan

Fan Dimensions: • 405mm x 405mm x 304mm

Please Note: It is the responsibility of the client or site management to ensure that the power used for fans is secure and tested. The above power consumption is for fans only and covers no extra electrical items. No other item should be connected to the fan power lines. The company accepts no responsibility for damages to equipment or damages to inflatable structures, injuries to persons or loss of earnings due to electrical power faults.

INSTALLATION & DERIG

Crew: • 3 persons (min)

Set Up Time: • From 4 hours

Inflation Time: • 20 mins for structure when fixed

Derig Time: • From 3.5 hours

PRODUCT ENHANCEMENTS

- Branding - Temporary/Permanent / Banners / Printed Covers
- Ground Anchor Fixing • Glazed Doors • Lighting • Trussing
- Flooring • High Pressure Supporting Tube Frame
- Custom Colored Fabric • All Spares of Basic Package

Please Note: Refer to separate later page for more detail on product enhancement. Please note the above technical data can be effected by additional product enhancements. The company reserves the right to add or remove product enhancements from product range without prior notice.



Product Variations

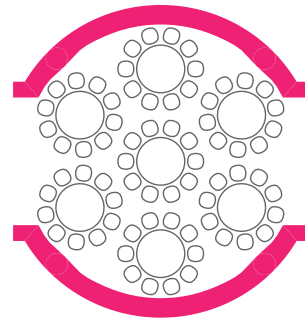

Restaurant Capacity:
7 Tables
70 Seats

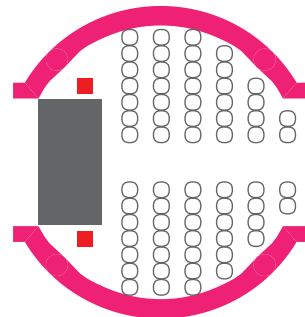

Conference Capacity:
4x2m Stage
66 Seats

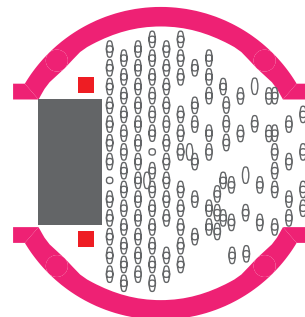

Concert Capacity:
4x2m Stage
120 People

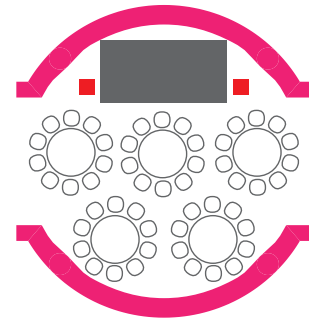

Caberet Capacity:
4x2m Stage
5 Tables
50 Seats

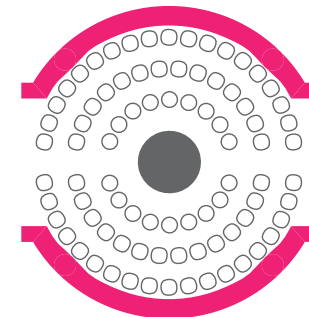

Arena Capacity:
2m Diameter Stage
84 Seats

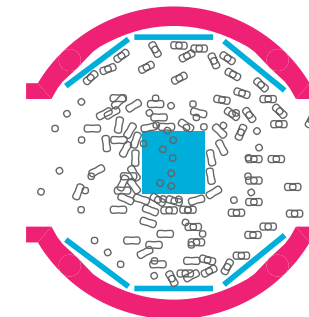

Exhibition Capacity:
8x Exhibition Stands
90 People

● Structure Footprint
 ⊙ Table + 10 Seats
 ● Stage
 ■ Speakers
 ■ Exhibit
 ⊕ People standing.

General Arrangement

Branding

Branding can be applied permanently to any of the Inflatable structures as screen print or digital printing at the source of production. Temporary branding can be added as vinyl or Dacron adhesive panels at any stage. Please note that not all artwork is suitable for printing on our structure range. It is advised sample artwork be supplied in an .eps format so we can advise the best solution. Full replaceable covers are available to the range. These can be branded and printed to ensure your structure matches your brand.

Custom colors and materials

All our structures are manufactured in ripstop nylon and reinforced PVC. As standard they are made in white and grey. Although a full color range is available, this may alter lead times and costs.

Other materials are available and we are happy to discuss specific needs / projects and will advise on what we feel is the most appropriate solution. All fabrics are tested for performance of flammability for textiles used in the construction of marquees and similar textiles structures to standards: BS 7837:1996 / BS 5438:1989.

Lighting

As an optional extra we can provide internal LED lighting systems which will transform the look and feel of your inflatable structure. The ambient lighting effect can be either one colour change or mixed to produce your perfect environment.

Trussing

The Inspire range of inflatable structures have been designed to be used as free standing products, trussing is not required to use them, however trussing can be added to enhance the environment. That can be used to hang PA equipment or other lighting options.

Doors & Closures

All of the Inspire Inflatable ranges come complete with zip in/ out doors as standard. Inspire also offers full aluminium double door systems. These provide fire safety openers and are fully lockable which provides increased security. The door systems are custom and made to be installed perfectly into our doorways.

Flooring

Flooring is available upon request and is offered to suit all event needs. We offer simple snap lock flooring. This offers light weight flooring and ideal for grass and concrete. It can be further enhanced by adding a finishing carpet.

Modularity

The entire Inspire range of Domes and Cubes can be joined together as the doorways are all standard. These can be jointed directly or by incorporating a space tunnel, these add an atmospheric walkway between the jointed structures and come in a range of lengths.

Transport

By its nature an inflatable structure packs down to considerably less than its inflated size. The largest of our range packs down to less than 2M³ which makes the structures ideal to store and use again. Each product will be supplied in its own storage bag and will be easily transported in an out of any venue.

Warranty

Inspire offers a 12 month warranty on the manufacture process and materials if the user manual and install guides are followed. Due to the nature of weather and installation conditions, Inspire reserves the right to carry out an onsite inspection and report which way the warranty will be met.

